

Horns and Sirens / Heavy-Duty multi-tone sounder
Multi-t.sounder WM 32 tne 115-230VAC GY

Part No.: 141.100.68

**MECHANICAL DATA**

Length	132 mm
Width	165 mm
Height	136 mm
Materials	PC/ABS
Housing colour	Grey
Protection category	IP66
Connection	Screw terminals
cross-sectional area maximum	2,50mm ² / 14AWG
Cable entry	Screwed cable gland
Cable entry minimum	d = 8 mm
Cable entry maximum	d = 12 mm
Tension relief	Present (conforms to VDE)
Type of fixing	Wall mounting
Working temperature minimum	-25°C
Working temperature maximum	+70°C
Weight with packaging	665 g
Product weight	575 g

ELECTRICAL DATA

Operating voltage	115-230V
Operating voltage type	AC
Operating voltage frequency	50Hz at 230V 60Hz at 115V
Operating voltage tolerance	+/- 10%
Rated operational voltage	230 VAC
Rated operational current	22 mA
Protection class	Protection class 2
Pollution degree	3
Overvoltage category	II
Isolation voltage	Ui = 250V; Uimp = 2.500V

OPTICAL DATA

Service life optical	5,000 h minimum
----------------------	-----------------

ACUSTICAL DATA

Volume (max) at 1m distance	110,0 dB (A)
Acoustic signal image	Multi-tone
Number of tones	32 tone
Acoustic service life	5,000 h minimum



For additional installation and mounting information, refer to the appropriate user guide at www.werma.com. This printed copy is for information only and is subject to alteration.

Horns and Sirens / Heavy-Duty multi-tone sounder
Multi-t.sounder WM 32 tne 115-230VAC GY

APPROVAL DATA	
Conforms with CE	Yes
WEEE	No
Conform with ATEX-directive	No
Conforms with CCC	No
Conforms with UL	No
Conforms with FCC	No
Conforms with IC	No
EAC certificate available	Yes
Conforms with AS-I	No
ICAO Certification	No
Conforms with GL	No
Conforms with RoHS CN	No
Conforms with VdS	No

DRAWING

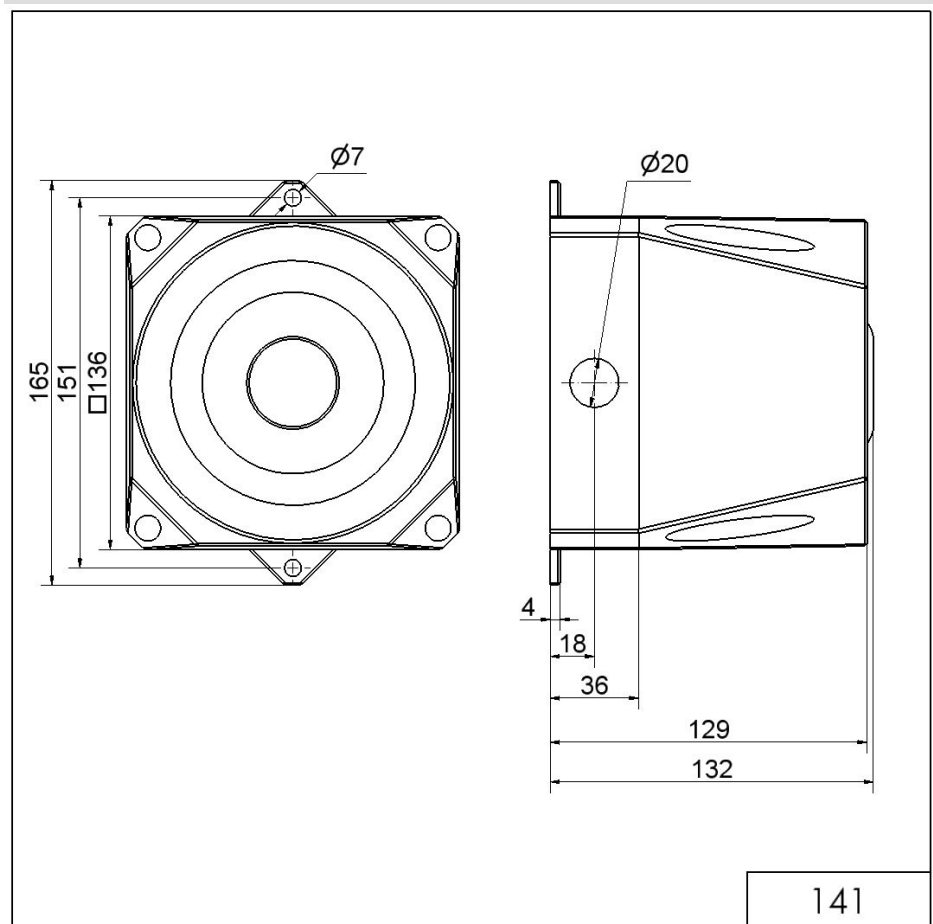

! For additional installation and mounting information, refer to the appropriate user guide at www.werma.com. This printed copy is for information only and is subject to alteration.