

Datasheet

Compact, Single-Point Devices for Error-Proofing of Bin-Picking Operations

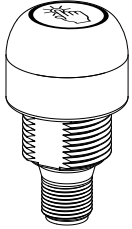

- Rugged, cost-effective and easy-to-install solutions for error-proofing and parts-verification applications
- Compact devices are completely self contained—No controller needed
- Illuminated dome provides an easy-to-see green job light: some models also light red for alternate operation
- Waterproof IP69K construction for washdown environments
- Easy actuation—no force required
- 12 V dc to 30 V dc operation
- Can be actuated with bare hands or in gloves

Models

Model	Function	Output	Connection ¹	Job Light		
K30APTGXDO	<ul style="list-style-type: none"> • Job light is ON at all times while job input is active • Touch activates output 	PNP, NO	Integral 4-pin M12/ Euro-style male quick disconnect	Green		
K30RPTGXDO		PNP, NC				
K30ANTGXDO		NPN, NO				
K30RNTGXDO		NPN, NC				
K30APTGRCO	<ul style="list-style-type: none"> • Job light is Green while job input is active • Touch activates output and overrides job light (turns Red) for visual verification that action was sensed 	PNP, NO		Integral 4-pin M12/ Euro-style male quick disconnect	Green (Red)	
K30RPTGRCO		PNP, NC				
K30ANTGRCO		NPN, NO				
K30RNTGRCO		NPN, NC				
K30APTGREQ	<ul style="list-style-type: none"> • Job light is Green at all times while job input is active • Touch activates output • A touch while job input is inactive causes unit to light Red, providing visual verification that sensor is functioning properly 	PNP, NO			Integral 4-pin M12/ Euro-style male quick disconnect	Green (Red)
K30RPTGREQ		PNP, NC				
K30ANTGREQ		NPN, NO				
K30RNTGREQ		NPN, NC				

Wiring Diagrams

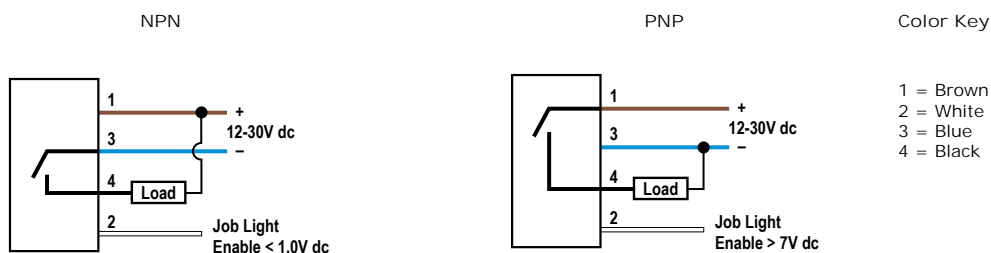

NOTE: Cabled wiring diagrams are shown. Quick disconnect (QD) wiring diagrams are functionally identical.

¹ Integral quick disconnect models are listed.

- To order the 2 m (6.5 ft) PVC cable model, omit the suffix "Q" in the model number. For example, K30APTGXDO.
- To order the 150 mm (6 in) PVC cable model with a 4-pin M12/Euro-style quick disconnect, replace the suffix "Q" with "QP" in the model number. For example, K30APTGXDOQP.
- Models with a quick disconnect require a mating cordset.



Specifications

Supply Voltage
12 V dc to 30 V dc

Supply Current
55 mA max current (exclusive of load)

Supply Protection Circuitry
Protected against reverse polarity and transient voltages

Output Rating
Maximum load: 150 mA
ON-state saturation voltage: < 2 V dc at 10 mA; < 2.5 V dc at 150 mA
OFF-state leakage current: <10 µA at 30 V dc

Output Response Time:
150 milliseconds On and Off

Vibration and Mechanical Shock
All models meet Mil. Std. 202F requirements method 201A (vibration: 10 Hz to 60 Hz max., double amplitude 0.06 in. maximum acceleration 10G). Also meets IEC 947-5-2; 30G 11 ms duration, half sine wave.

Environmental Rating
IEC IP67, IP69K per DIN 40050-9.
Cabled models also meet IP69K if the cable and cable entrance are protected from high-pressure spray.
Enclosure Type 4X, 13

Storage
-40 °C to +70 °C (-40 °F to +158 °F)

Operating Conditions
Temperature: -40 °C to +50 °C (-40 °F to +122 °F)
Humidity: 90% at 50 °C maximum relative humidity (non-condensing)

Certifications



Power-Up Delay
300 milliseconds

Construction
Housing: polycarbonate
Translucent dome: polycarbonate
Mounting nut: PBT

Indicators
Job ("pick") indicator: Green
Pick sensed indicator: Red or Off, depending on model

Mounting
M22 x 1.5 Threaded base, max torque 2.25 N·m (20 in-lbf)

Connections
Integral 4-pin M12/Euro style QD, or 2 m (6.5 ft) PVC integral cable

Required Overcurrent Protection



WARNING: Electrical connections must be made by qualified personnel in accordance with local and national electrical codes and regulations.

Overcurrent protection is required to be provided by end product application per the supplied table.
Overcurrent protection may be provided with external fusing or via Current Limiting, Class 2 Power Supply.
Supply wiring leads < 24 AWG shall not be spliced.
For additional product support, go to www.bannerengineering.com.

Supply Wiring (AWG)	Required Overcurrent Protection (Amps)
20	5.0
22	3.0
24	2.0
26	1.0
28	0.8
30	0.5

Dimensions

All measurements are listed in millimeters [inches], unless noted otherwise.

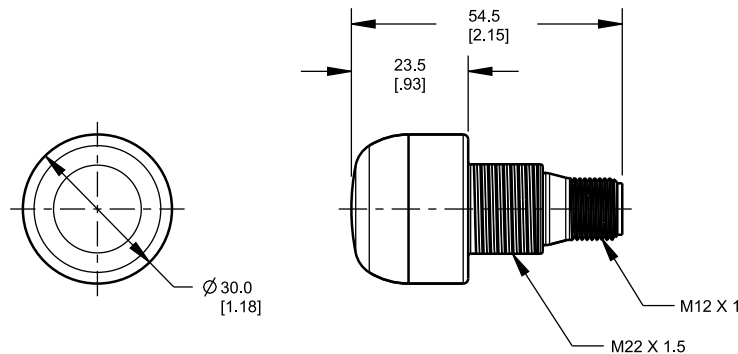

Accessories

Cordsets

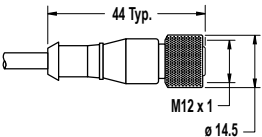
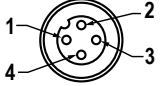
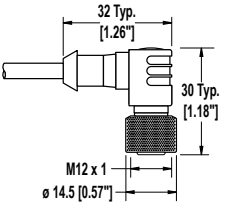
4-Pin Threaded M12/Euro-Style Cordsets				
Model	Length	Style	Dimensions	Pinout (Female)
MQDC-406	1.83 m (6 ft)	Straight		 <p>1 = Brown 2 = White 3 = Blue 4 = Black</p>
MQDC-415	4.57 m (15 ft)			
MQDC-430	9.14 m (30 ft)			
MQDC-450	15.2 m (50 ft)			
MQDC-406RA	1.83 m (6 ft)	Right-Angle		
MQDC-415RA	4.57 m (15 ft)			
MQDC-430RA	9.14 m (30 ft)			
MQDC-450RA	15.2 m (50 ft)			

Brackets

SMB22A

- Right-angle bracket with curved slot for versatile orientation
- 12-ga. stainless steel
- Mounting hole for 22 mm sensor

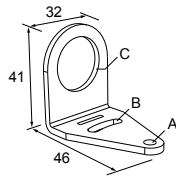

Hole center spacing: A to B = 26.0
Hole size: A = ø 4.6, B = 4.6 x 16.9, C = 22.2

SMB22FVK

- V-clamp, flat bracket and fasteners for mounting to pipe or extensions
- Clamp accommodates 28 mm diameter tubing or 1 in. square extrusions
- 22 mm hole for mounting sensor

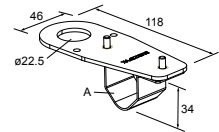

Hole size: A = ø 22.5

SMB22RAVK

- V-clamp, right-angle bracket and fasteners for mounting to pipe or extensions
- Clamp accommodates 28 mm diameter tubing or 1 in. square extrusions
- 22 mm hole for mounting sensor

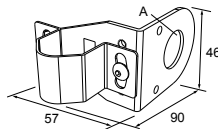

Hole size: A = ø 22.5

SMBAMS22P

- Flat SMBAMS series bracket with 22 mm hole for mounting sensors
- Articulation slots for 90+° rotation
- 12-ga. (2.6 mm) cold-rolled steel

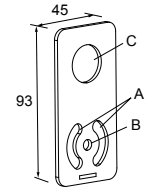

Hole center spacing: A = 26.0, A to B = 13.0
Hole size: A = 26.8 x 7.0, B = ø 6.5, C = ø 22.5

SMBAMS22RA

- Right-angle SMBAMS series bracket with 22 mm hole for mounting sensors
- Articulation slots for 90+° rotation
- 12-ga. (2.6 mm) cold-rolled steel

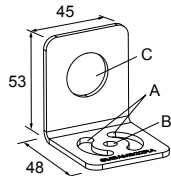

Hole center spacing: A = 26.0, A to B = 13.0
Hole size: A = 26.8 x 7.0, B = ø 6.5, C = ø 22.5

TC-K30-CL

- Touch cover

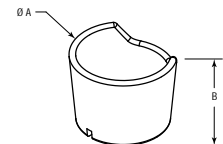

Diameter: A = 40.7
Height: B = 31

All measurements are listed in millimeters, unless noted otherwise.

Banner Engineering Corp. Limited Warranty

Banner Engineering Corp. warrants its products to be free from defects in material and workmanship for one year following the date of shipment. Banner Engineering Corp. will repair or replace, free of charge, any product of its manufacture which, at the time it is returned to the factory, is found to have been defective during the warranty period. This warranty does not cover damage or liability for misuse, abuse, or the improper application or installation of the Banner product.

THIS LIMITED WARRANTY IS EXCLUSIVE AND IN LIEU OF ALL OTHER WARRANTIES WHETHER EXPRESS OR IMPLIED (INCLUDING, WITHOUT LIMITATION, ANY WARRANTY OF MERCHANTABILITY OR FITNESS FOR A PARTICULAR PURPOSE), AND WHETHER ARISING UNDER COURSE OF PERFORMANCE, COURSE OF DEALING OR TRADE USAGE.

This Warranty is exclusive and limited to repair or, at the discretion of Banner Engineering Corp., replacement. IN NO EVENT SHALL BANNER ENGINEERING CORP. BE LIABLE TO BUYER OR ANY OTHER PERSON OR ENTITY FOR ANY EXTRA COSTS, EXPENSES, LOSSES, LOSS OF PROFITS, OR ANY INCIDENTAL, CONSEQUENTIAL OR SPECIAL DAMAGES RESULTING FROM ANY PRODUCT DEFECT OR FROM THE USE OR INABILITY TO USE THE PRODUCT, WHETHER ARISING IN CONTRACT OR WARRANTY, STATUTE, TORT, STRICT LIABILITY, NEGLIGENCE, OR OTHERWISE.

Banner Engineering Corp. reserves the right to change, modify or improve the design of the product without assuming any obligations or liabilities relating to any product previously manufactured by Banner Engineering Corp. Any misuse, abuse, or improper application or installation of this product or use of the product for personal protection applications when the product is identified as not intended for such purposes will void the product warranty. Any modifications to this product without prior express approval by Banner Engineering Corp will void the product warranties. All specifications published in this document are subject to change; Banner reserves the right to modify product specifications or update documentation at any time. Specifications and product information in English supersede that which is provided in any other language. For the most recent version of any documentation, refer to: www.bannerengineering.com.