

ISSUE NUMBER	
ORIGINAL	①
ADD IN NOTES RATED CURRENT & VOLTAGE R.STA.MONICA	②
PINOUT ADDED N.SONDH	③
ADD DETAIL A P.M.	④
ADD TOTAL HEIGHT DIM 1.70 WAS 1.50 P.M.	⑤

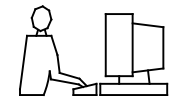

THIS IS A C.A.D. GENERATED DRAWING
DO NOT MAKE MANUAL REVISIONS TO MASTER.

TOLERANCE UNLESS OTHERWISE SPECIFIED IN MM:
0.0 ± 0.20
0.00 ± 0.10
0.000 ± 0.05
ANGLE x°

DETAIL A

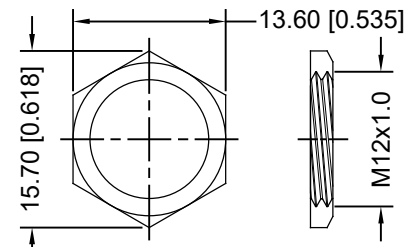
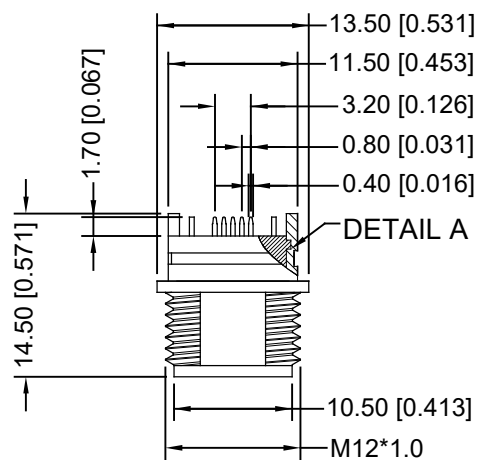
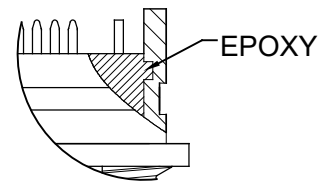

NUT

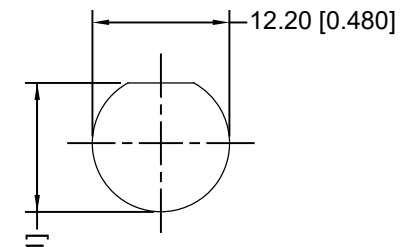

CUT OUT

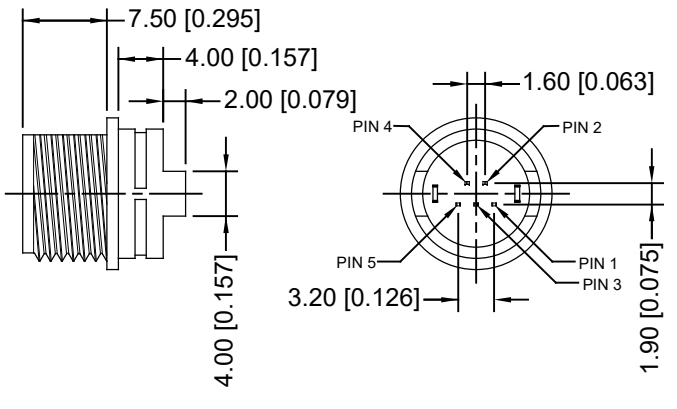
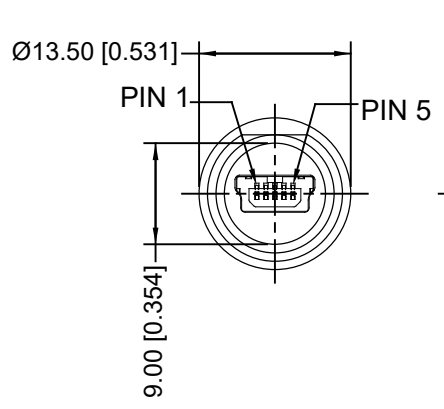
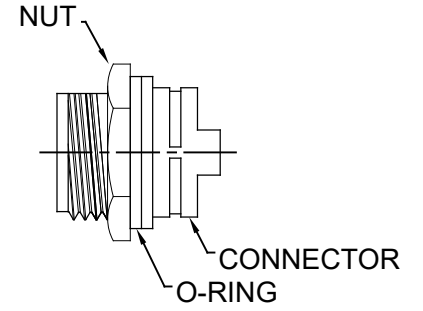

- MATERIAL :
 - 1-1 . HOUSING : LCP UL94V-0 ; COLOR : BLACK
 - 1-2 . CONTACT : PHOSPHOR BRONZE
 - 1-3 . SHELL : BRASS
- PARTS
 - 2-1 . EXTERNAL NUT : PBT UL 94V-0 ; COLOR : BLACK
 - 2-2 . O-RING : EPDM (1.5*9.5) ; COLOR : BLACK.
- PLATING
 - 3-1 . CONTACT : GOLD PLATING ON CONTACT AREA
BRIGHT TIN ON SOLDER AREA
 - 3-2 . SHELL : NICKEL PLATING ON OVER ALL
- SPECIFICATIONS :
 - 4-1. Water proof: IP67
 - 4-2. Rated Current: 1A
 - 4-3. Rated Voltage: 30V
- OPERATING TEMPERATURE:-25C TO +85C



RoHS COMPLIANT THIS SERIES FULLY CONFORMS TO THE EUROPEAN UNION DIRECTIVES 2011/65/EU FOR RoHS COMPLIANCY.

WATERPROOF MINI USB TYPE B, 5P (FEMALE)		ACAD REFERENCE NO.: 690-W05-260-044	
		DRAWN: R.STA.MONICA	DATE: MAY.01/2014
		CHECKED: R.S.M.	DATE: JAN. 21/2020
		PART NUMBER	
YOUR CONNECTION TO QUALITY & SERVICE		690-W05-260-044	
		SHEET 1 OF 1	
THESE DRAWINGS AND SPECIFICATIONS ARE THE PROPERTY OF EDAC INC., AND SHALL NOT BE REPRODUCED, OR COPIED OR USED AS THE BASIS FOR THE MANUFACTURE OR SALE OF APPARATUS WITHOUT WRITTEN PERMISSION.		DRAWING NUMBER	
		690-W05-260-044	
		ISSUE	
		5	